

PRODUCT SPECIFICATIONS

產品規格

系列 Collection	名稱 Product	標配光源 Rating bulb	更換標配光源 Replaceable bulb	能源等級 Energy Class	淨重 (kg)	壁蓋 Canopy	壁鐵 Plate	防護等級 Class	認證 Certificate
ARCHER 射手座	ARCHER D	E27 1 x Max 46W Halogen	14W CFL/ 8W LED bulb	A+, A, B, C, D	5.1			II	
	ARCHER F	E27 1 x Max 46W Halogen	14W CFL/ 8W LED bulb	A+, A, B, C, D	13.2			II	ETL
	ARCHER F XL	E27 3 x Max 46W Halogen	14W CFL/ 8W LED bulb	A+, A, B, C, D	33.5			II	ETL, CE
CARRY 盛	CARRY D	E27 2 x Max 46W Halogen	14W CFL/ 8W LED bulb	A+, A, B, C, D	4.3			II	ETL
	CARRY F	E27 2 x Max 46W Halogen	14W CFL/ 8W LED bulb	A+, A, B, C, D	6.8			II	ETL, CE
	CARRY D MINI	E27 1 x Max 46W Halogen	14W CFL/ 8W LED bulb	A+, A, B, C, D	2.3			II	CE
CASTLE 堡壘	CASTLE P CONE XS	E27 1 x Max 30W Halogen	9W CFL/ 6W LED bulb	A+, A, B, C, D	1.1	A	A	II	CE
	CASTLE P CONE S	E27 1 x Max 77W Halogen	23W CFL/ 14W LED bulb	A+, A, B, C, D	2.3	A	A	II	CE
	CASTLE P BELL XS	E14 1 x Max 30W Halogen	9W CFL/ 6W LED bulb	A+, A, B, C, D	1.1	A	A	II	CE
	CASTLE P BELL S	E14 1 x Max 77W Halogen	23W CFL/ 14W LED bulb	A+, A, B, C, D	2.5	A	A	II	CE
	CASTLE P XS	G9 1 x Max 33W		D	0.7	A	A	II	CE
	CASTLE P S	E27 1 x Max 77W Halogen	23W CFL/ 14W LED bulb	A+, A, B, C, D	2.0	A	A	II	ETL, CE
	CASTLE P M	E27 1 x Max 77W Halogen	23W CFL/ 14W LED bulb	A+, A, B, C, D	6.7	A4	B2	II	ETL, CE
	CASTLE P L	E27 1 x Max 77W Halogen	23W CFL/ 14W LED bulb	A+, A, B, C, D	14.1	A4	B2	II	CE
	CASTLE W S LED	LED 5W 3000K 425lm CRI80		A+	1.6	B6	C2	III	
	CASTLE W R LED	LED 5W 3000K 425lm CRI80		A+	1.3	B6	C2	III	
CHEVALIER 騎士	CHEVALIER D	G9 1 x Max 33W		D	3.7			II	
	CHEVALIER W	G9 1 x Max 33W		D	1.3	A8	B1	II	
CHINA 閣	CHINA D	E27 2 x Max 60W Halogen	14W CFL/ 8W LED bulb	A+, A, B, C, D	3.7			II	ETL, CE
	CHINA F	E27 2 x Max 60W Halogen	14W CFL/ 8W LED bulb	A+, A, B, C, D	8.8			II	
CONCOM 相伴	CONCOM W	E14 1 x Max 30W Halogen	9W CFL/ 6W LED bulb	A+, A, B, C, D	1.4	D1	A4	II	CE
DAMO 達摩	DAMO D S	E27 1 x Max 46W Halogen	14W CFL/ 8W LED bulb	A+, A, B, C, D	2.8			II	CE
	DAMO D	E27 2 x Max 46W Halogen	14W CFL/ 8W LED bulb	A+, A, B, C, D	4.8			II	
	DAMO P	E27 2 x Max 40W Halogen	9W CFL/ 6W LED bulb	A+, A, B, C, D	4.8	A	A	II	
DODO 嘟嘟鳥	DODO D	E27 1 x Max 46W Halogen	14W CFL/ 8W LED bulb	A+, A, B, C, D	2.5			II	CE
	DODO F	E27 1 x Max 46W Halogen	14W CFL/ 8W LED bulb	A+, A, B, C, D	3.7			II	CE
	DODO P	E27 1 x Max 46W Halogen	14W CFL/ 8W LED bulb	A+, A, B, C, D	1.1	A	D1	II	CE
	DODO W	E27 1 x Max 46W Halogen	14W CFL/ 8W LED bulb	A+, A, B, C, D	4.4	B	A6	II	
DOBI 多比	DOBI D	E14 1 x Max 30W Halogen	9W CFL/ 6W LED bulb	A+, A, B, C, D				II	
	DOBI P	E14 1 x Max 30W Halogen	9W CFL/ 6W LED bulb	A+, A, B, C, D				II	
	DOBI PR-70	E14 1 x Max 30W Halogen	9W CFL/ 6W LED bulb	A+, A, B, C, D				II	
	DOBI PR-120	E14 1 x Max 30W Halogen	9W CFL/ 6W LED bulb	A+, A, B, C, D		A	D1	II	
	DOBI W	E14 1 x Max 30W Halogen	9W CFL/ 6W LED bulb	A+, A, B, C, D		A10	A10	II	

系列 Collection	名稱 Product	標配光源 Rating bulb	更換標配光源 Replaceable bulb	能源等級 Energy Class	淨重 (kg)	壁蓋 Canopy	壁鐵 Plate	防護等級 Class	認證 Certificate
DORA 朵拉	DORA P	LED 1 x 3000K CRI90		A+	1.2	A1	A6	III	
	DORA P3	LED 3 x 3000K CRI90		A+	3.6	A13	A8	III	
	DORA PL5	LED 5 x 3000K CRI90		A+	6.5	C7	A11	III	
	DORA P8	LED 8 x 3000K CRI90		A+	11.2			III	
	DORA P12	LED 12 x 3000K CRI90		A+	18.6			III	
DOME 蒼穹	DOME P XS LED	LED 5W 3000K 425lm CRI80		A+	0.6	A1	A6	III	
	DOME P S	G9 1 x Max 33W		D	1.4	A	A	II	
	DOME P M	E27 1 x Max 77W Halogen	23W CFL/ 14W LED bulb	A+, A, B, C, D	2.4	A	A	II	CE
	DOME P L	E27 1 x Max 77W Halogen	23W CFL/ 14W LED bulb	A+, A, B, C, D	4.2	A	A6	II	ETL, CE
DOME P XL	E27 3 x Max 46W Halogen	14W CFL/ 8W LED bulb	A+, A, B, C, D			A4	B2	II	
GELATO 冰紛	GELATO P	E27 1 x Max 46W Halogen	14W CFL/ 8W LED bulb	A+, A, B, C, D	3.4	A3	A6	II	
GLACIER 冰河	GLACIER P	G9 1 x Max 33W		D	1.1	A	A	II	
	GLACIER W	G9 1 x Max 33W		D	1.6	D	E1	II	
ICE 晶采	ICE P20	G4 20 x Max 10W		C	11.0	A7	A3	III	CE
JOJO 悠悠	JOJO P	G6.35 1 x Max 50W		C	1.3	A5	A	III	
	JOJO P3	G6.35 1 x Max 50W		C	6.0	C4	A9	III	
KAZOKU 家族	KAZOKU P	G9 4 x 33W		D	5.2	C5	A1	II	CE
LAITO 光	LAITO D	E27 1 x Max 46W Halogen	14W CFL/ 8W LED bulb	A+, A, B, C, D	2.0			II	
	LAITO F	E27 1 x Max 46W Halogen	14W CFL/ 8W LED bulb	A+, A, B, C, D	3.6			II	
	LAITO W	E27 1 x Max 46W Halogen	14W CFL/ 8W LED bulb	A+, A, B, C, D	0.8	B2	A5	II	
	LAITO P S	E27 1 x Max 46W Halogen	14W CFL/ 8W LED bulb	A+, A, B, C, D	0.6	A	A	II	
	LAITO P M	E27 1 x Max 46W Halogen	14W CFL/ 8W LED bulb	A+, A, B, C, D	0.9	A	A	II	
	LAITO P L	E27 1 x Max 77W Halogen	23W CFL/ 14W LED bulb	A+, A, B, C, D	1.5	A	A	II	CE
	LAITO MINI D	E14 1 x Max 30W Halogen	9W CFL/ 6W LED bulb	A+, A, B, C, D	1.4			II	
	LAITO MINI W	E14 1 x Max 30W Halogen	9W CFL/ 6W LED bulb	A+, A, B, C, D	0.5	A11	E	II	
LAITO MINI P	E14 1 x Max 30W Halogen	9W CFL/ 6W LED bulb	A+, A, B, C, D	0.5	A12	A5	II		
LAITO WOOD 沐光	LAITO WOOD D	E27 1 x Max 46W Halogen	14W CFL/ 8W LED bulb	A+, A, B, C, D	2.1			II	ETL, CE
LALU 光華島	LALU D	E27 1 x Max 46W Halogen	14W CFL/ 8W LED bulb	A+, A, B, C, D	3.2			II	
	LALU F	E27 1 x Max 46W Halogen	14W CFL/ 8W LED bulb	A+, A, B, C, D	5.1			II	

PRODUCT SPECIFICATIONS

產品規格

系列 Collection	名稱 Product	標配光源 Rating bulb	更換標配光源 Replaceable bulb	能源等級 Energy Class	淨重 (kg)	壁蓋 Canopy	壁鐵 Plate	防護等級 Class	認證 Certificate
LALU+ 拉魯	LALU+ D	E27 1 x Max 14W CFL	8W LED bulb	A+, A	2.8			II	
	LALU+ P	E27 1 x Max 14W CFL	8W LED bulb	A+, A	4.7			II	
	LALU+ P4	E27 4 x Max 14W CFL	8W LED bulb	A+, A	4.8	C5	A1	II	
MIST 嵐	MIST P M	E27 1 x Max 46W Halogen	8W LED bulb	A+, A, B, C, D	1.3	D2	A12	II	
	MIST P L	E27 R80 1 x Max 75W	14W LED bulb	A+, A, B, C, D	2.6	D2	A12	II	
MUMU 目木	MUMU P 80	LED 25W 3000K 1680lm CRI90		A+	2.3			III	
	MUMU P 120	LED 32W 3000K 2150lm CRI90		A+	2.9			III	
	MUMU W	LED 5.7W 3000K 400lm CRI90		A+	0.8			III	
NEWTON 蘋果	NEWTON P	E27 1 x Max 77W Halogen	23W CFL/ 14W LED bulb	A+, A, B, C, D	1.9	A	A	II	
NUMEN 精靈	NUMEN D	E27 1 x Max 46W Halogen	14W CFL/ 8W LED bulb	A+, A, B, C, D	0.7			II	ETL
PENSÉE 思想	PENSÉE D	G9 1 x 33W (included)		D	2.0			II	
PLANET 行星	PLANET D	LED 8.6W 3000K 600lm CRI90		A+	3.6			III	
	PLANET F	LED 8.6W 3000K 600lm CRI90		A+	6.2			III	
	PLANET W	LED 8.6W 3000K 600lm CRI90		A+	2.5			III	
QIN 沁	QIN W LED	LED 5W 3000K 425lm CRI80		A+	0.6	A2	E	III	
	QIN P LED	LED 5W 3000K 425lm CRI80		A+	0.4	A1	A6	III	
	QIN P	E27 1 x Max 46W Halogen	14W CFL/ 8W LED bulb	A+, A, B, C, D	1.8	A3	A6	II	
	QIN P3	E27 3 x Max 46W Halogen	14W CFL/ 8W LED bulb	A+, A, B, C, D	5.6	C6	A1	II	CE
SNOWFLAKE 雪花	SNOWFLAKE P7	E27 7 x Max 40W Crown	7W LED Crown	A, B, C, D	9.6	A	A	CLASS II	
	SNOWFLAKE W	E27 1x Max 40W Crown	7W LED Crown	A, B, C, D	1.5	A6	B	CLASS II	
STALA 結晶	STALA 36	E27 1 x Max 77W Halogen	23W CFL/ 14W LED bulb	A+, A, B, C, D	3.0	A	A	II	CE
	STALA 50	E27 3 x Max 46W Halogen	14W CFL/ 8W LED bulb	A+, A, B, C, D	5.7	A4	B2	II	CE
	STALA 55	E27 3 x Max 46W Halogen	14W CFL/ 8W LED bulb	A+, A, B, C, D	6.4	A4	B2	II	

系列 Collection	名稱 Product	標配光源 Rating bulb	更換標配光源 Replaceable bulb	能源等級 Energy Class	淨重 (kg)	壁蓋 Canopy	壁鐵 Plate	防護等級 Class	認證 Certificate
SALUTE 樂杯	SALUTE WINE	E27 1 x Max 40W filament	4W LED Retrofit/ PAR30 50W	A+, A, B, C, D	0.9	A	A	II	
	SALUTE BELL	E27 1 x Max 40W filament	4W LED Retrofit/ PAR30 50W	A+, A, B, C, D	1.1	A	A	II	
	SALUTE BELL R	E27 1 x Max 46W Halogen	14W CFL/ 8W LED bulb	A+, A, B, C, D	1.4	A	A	II	ETL, CE
	SALUTE CAKE	E27 1 x Max 40W filament	4W LED Retrofit/ PAR30 50W	A+, A, B, C, D	0.9	A	A	II	CE
STREAM 彗星	STREAM S	LED 5W 3000K 425lm CRI80		A+	0.8			II	
	STREAM L	LED 5W 3000K 425lm CRI80		A+	1.3			II	
T1	T1 PL5	LED 5 x 5W 3000K 2255lm CRI90		A+		C7	A11	III	
	T1 W1	LED 1 x 5W 3000K 451lm CRI90		A+		A9	B3	III	
	T1 W2	LED 2 x 5W 3000K 776lm CRI90		A+		A9	B3	III	
	T1 W1 44	LED 1 x 5W 3000K 451lm CRI90		A+				III	IP 44
	T1 W2 44	LED 1 x 5W 3000K 451lm CRI90		A+				III	IP 44
TICKTOCK 滴答	TICKTOCK D	LED 6 x 1W 3000K CRI80		A+	1.8			II	
	TICKTOCK F	LED 6 x 1W 3000K CRI80		A+	3.3			II	
XY 艾克司歪	XY D	LED 8 x 1W 3000K CRI80		A+	2.2			II	
	XY F	LED 8 x 1W 3000K CRI80		A+	3.6			II	
	XY P18	LED 18 x 1W 3000K CRI80		A+	2.5	C	A7	III	
	XY P24	LED 24 x 1W 3000K CRI80		A+	3.2	C1	A1	III	
ZEN 禪	ZEN W 102	G9 1 x Max 33W		D	0.9	B5	C1	III	
	ZEN W 103	G9 1 x Max 33W		D	1.0	B5	C1	III	
ZHE 柘	ZHE D	E27 1 x Max 46W Halogen	14W CFL/ 8W LED bulb	A+, A, B, C, D	2.8			II	ETL
	ZHE P4	E27 4x Max 46W Halogen	14W CFL/ 8W LED bulb	A+, A, B, C, D	7.6	A3	A6	II	ETL, CE
	ZHE P6	E27 6 x Max 46W Halogen	14W CFL/ 8W LED bulb	A+, A, B, C, D	10.8	A3	A6	II	ETL

CE CE: Lamp approved to be compliant with the European Directives.

CLASS I: Lamp of Class I with protective earth connection.

ETL ETL: Lamp approved and listed in ETL for North American Area.

CLASS II: Live parts are equipped with additional protective insulation. Connection of a protective earth conductor is not permitted.

IP 65 IP65: Dust-proof luminaire protected against ingress of water jets.

CLASS III: Protection against electric shock is based on use of safety extra low voltage.

IP 44 IP44: Protection against touching active parts with a 1 mm thick wire and against ingress of splash water.

CANOPY TYPE

壁蓋種類

A

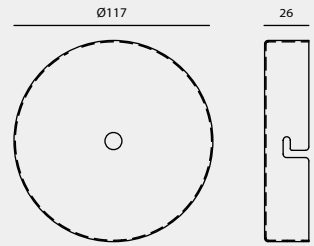

A1

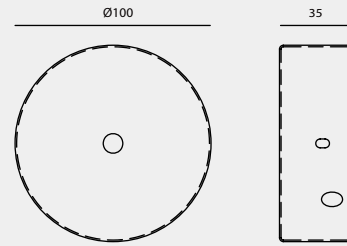

A2

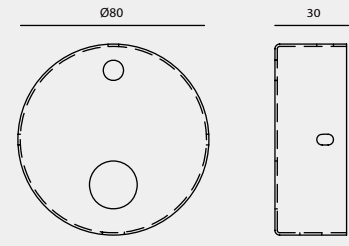

A3

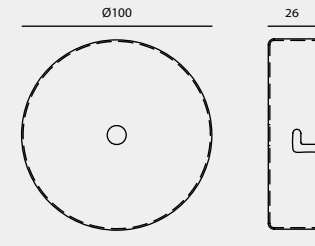

A4

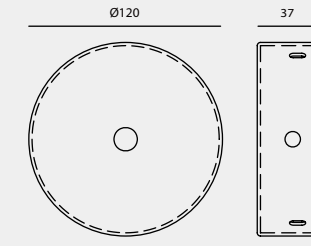

A5

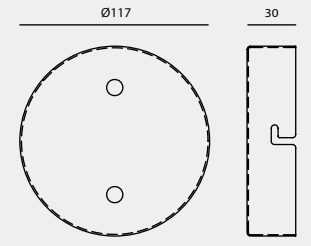

A6

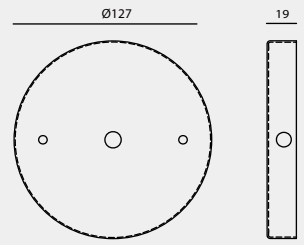

A7

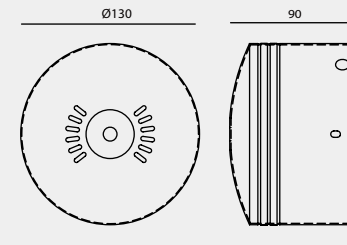

A8

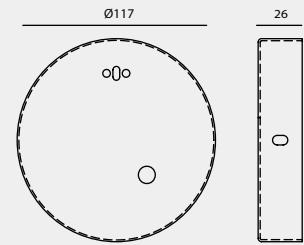

A9

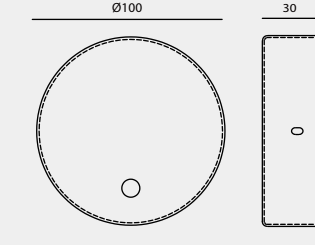

A11

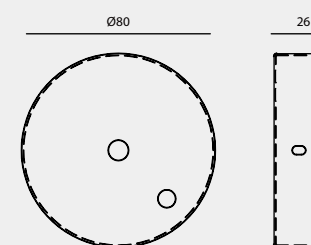

A12

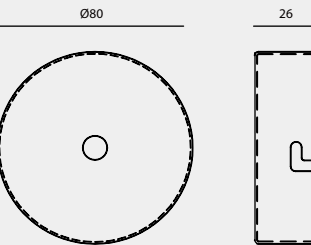

A13

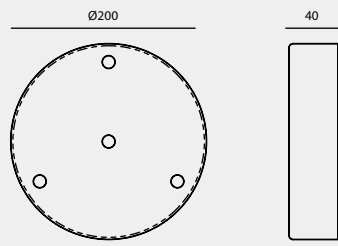

A14

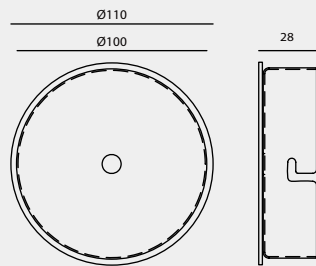

B

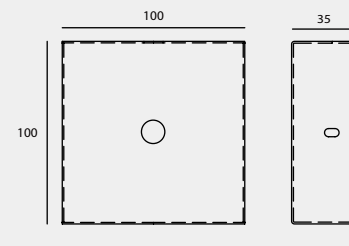

B1

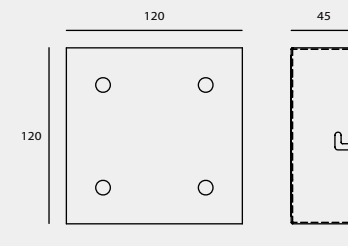

B2

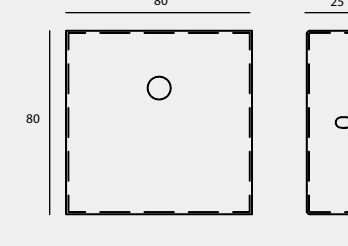

B3

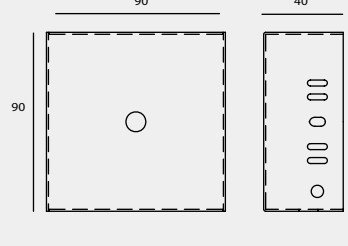

B4

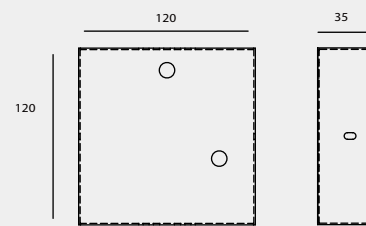

B5

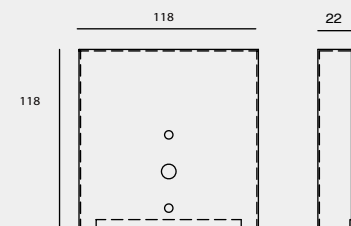

B6

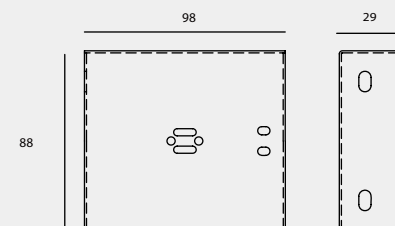

CANOPY TYPE

壁 蓋 種 類

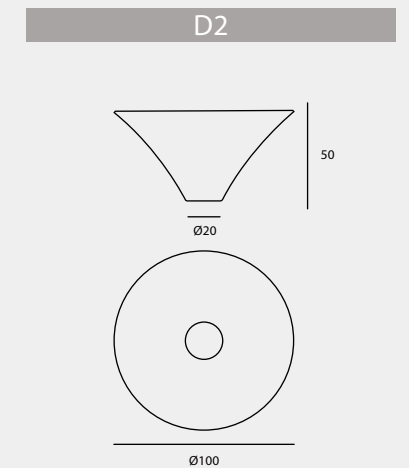
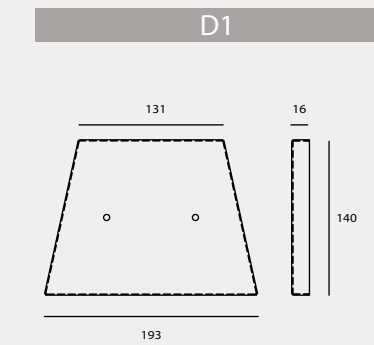
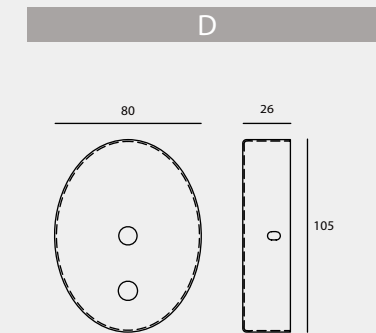
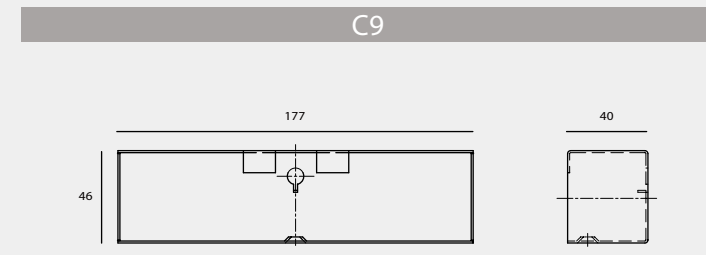
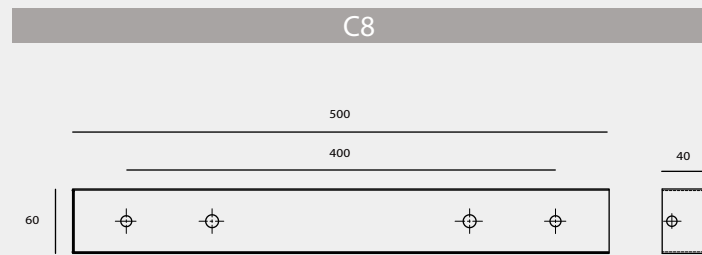
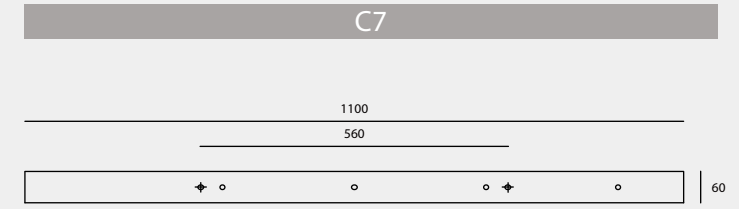
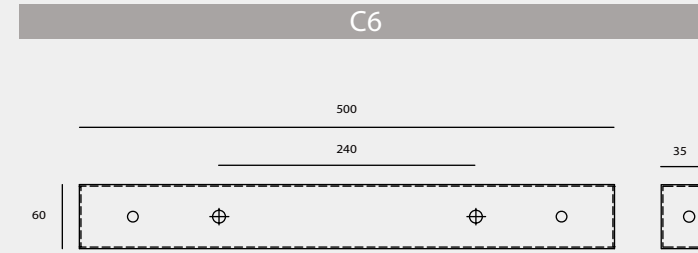
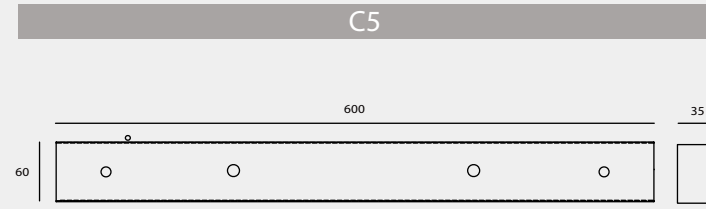
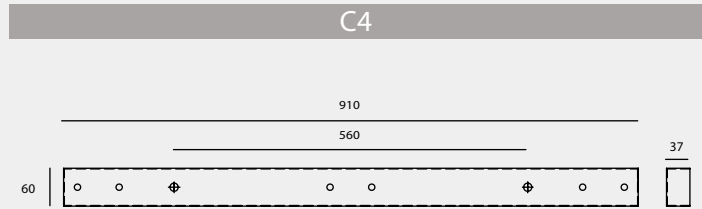
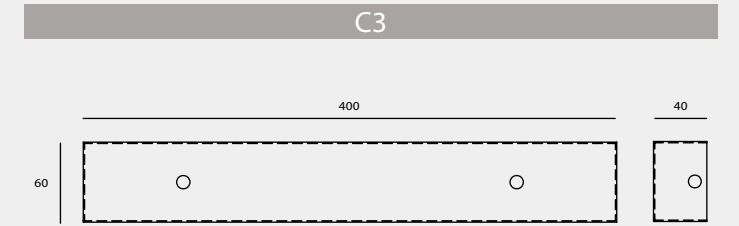
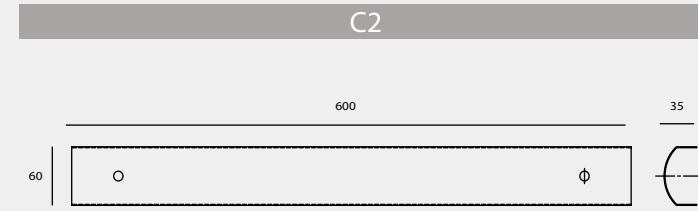
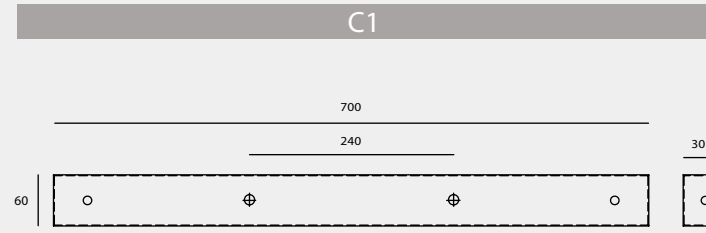
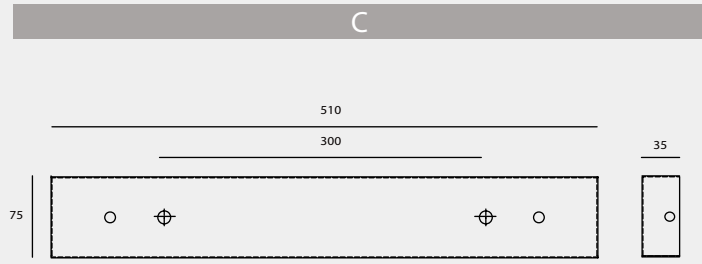

BACK PLATE TYPE

壁鐵種類

A

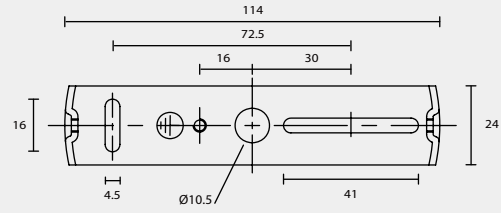

A1

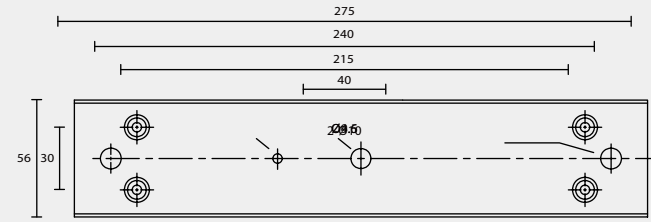

A2

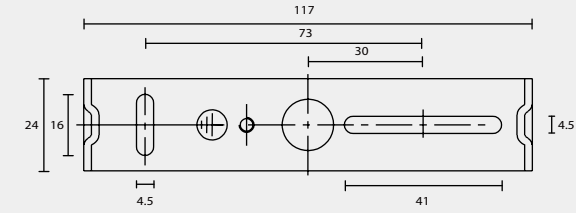

A3

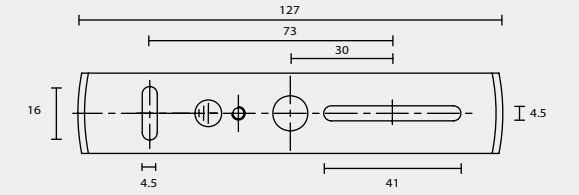

A4

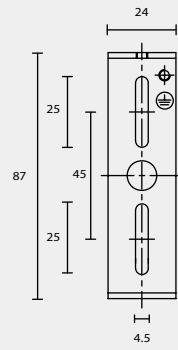

A5

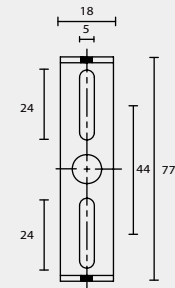

A6

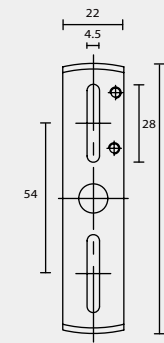

A7

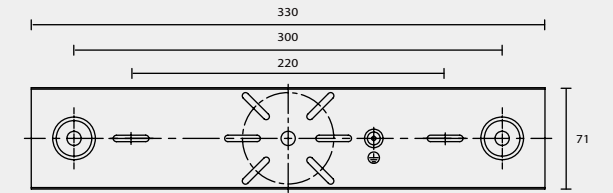

A8

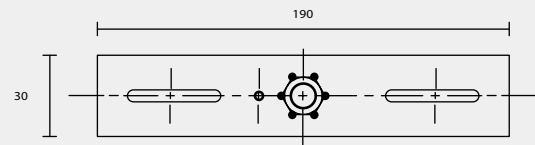

A9

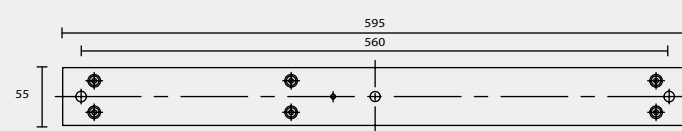

A10

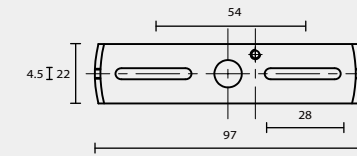

A11

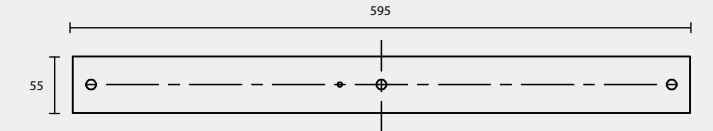

A12

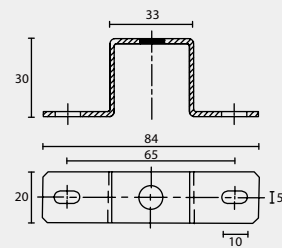

A13

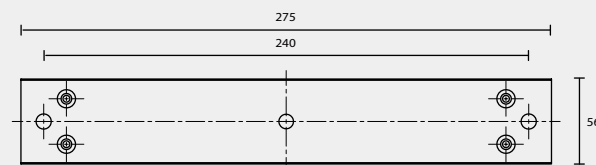

B

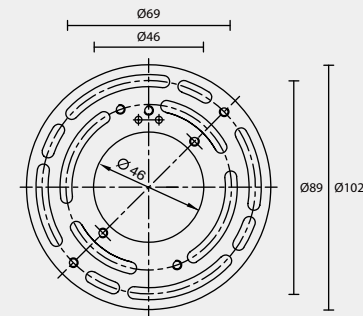

B1

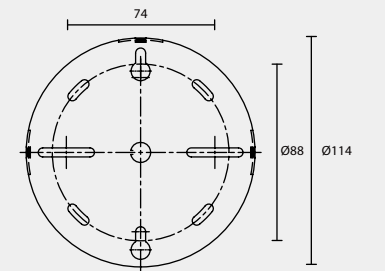

BACK PLATE TYPE

壁 鐵 種 類

B2

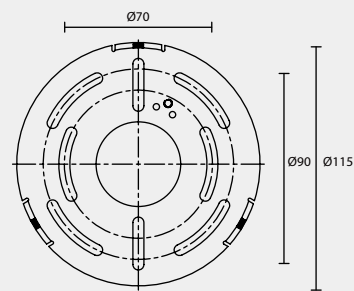

B3

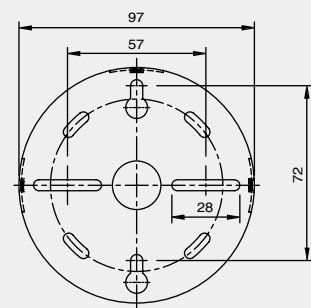

C

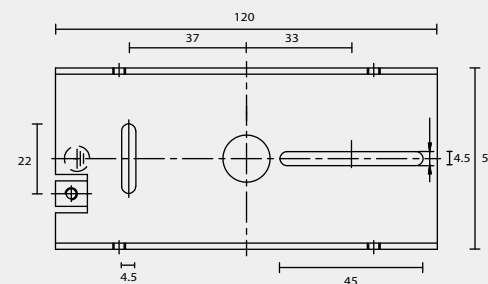

C1

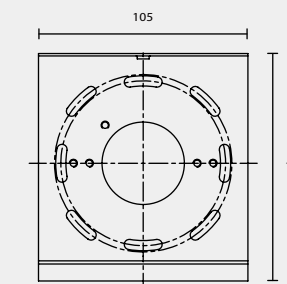

C2

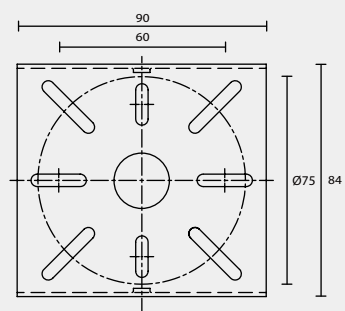

D

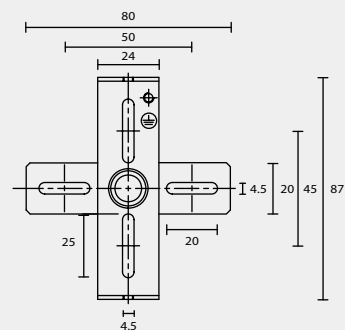

D1

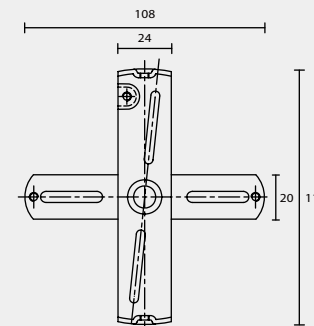

D2

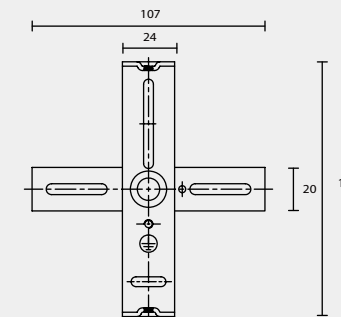

E

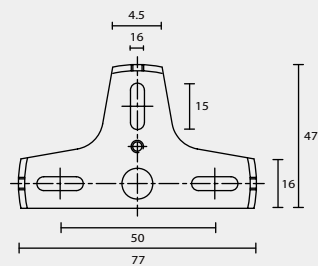

E1

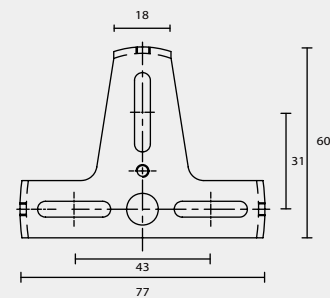

F

